

TUBELED_40 II Power, Länge 365 mm

Artikel-Nr.: 118210-01
EAN: 4260556622859

Bestell-Nr.:	118210-01
Modell:	TUBELED_40 II
Bauform:	LED Aufbau Maschinenleuchte
Leuchtmittel:	SMD LED
Lampenleistung:	~16 W
Lampenlichtstrom:	2139 lm
Lampenlichtausbeute:	131 lm/W
Lichtverteilung:	Light Forming Technology
Lichtfarbe:	Tageslichtweiß (5200 - 5700K)
Anschlusswert Leuchte:	24V DC \pm 10%
Anschluss Leuchte:	M12 A-kodiert
Schutzart:	IP67/IP69K
Schutzklasse:	III
Entblendung:	Diffusor ESG
Abstrahlwinkel:	100°
Betriebstemperatur:	-30... +60 °C
Farbwiedergabe (Ra):	> 85
Lampenlebensdauer:	> 60.000 h
Material Gehäuse:	Aluminium
Material Abdeckung:	Sicherheitsglas, 4 mm
Höhe [B] x Breite [C]:	29 mm x 40 mm
Länge [A]:	365 mm
Gewicht:	450 g
Bruttogewicht:	600 g
Risikogruppe (DIN EN 62471):	freie Gruppe
Kennzeichnung:	CE, UKCA, ETL Listed
Befestigungszubehör:	optional
Dimmbar:	optional über Zubehör
Gefertigt in:	Deutschland

Lampenlebensdauer in Betriebsstunden (L80/B10)

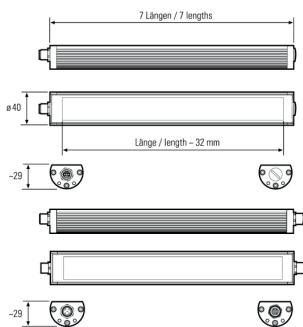
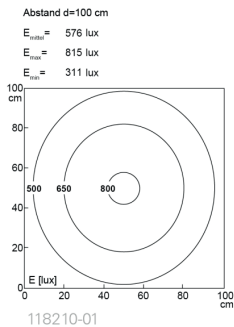

TUBELED_40 II Power, 365 mm

Item number: 118210-01
EAN: 4260556622859

Order number:	118210-01
Model:	TUBELED_40 II
Type:	LED surface-mounted luminaire for machines
Illuminant:	SMD LED
Power consumption:	~16 W
Lamp luminous flux:	2139 lm
Lamp luminous efficiency:	131 lm/W
Light distribution:	Light Forming Technology
Light colour:	daylight white (5200 - 5700K)
Connected load:	24V DC \pm 10%
Connection (connector):	M12 A-type encoded
Degree of protection:	IP67/IP69K
Class of protection:	III
Glare-free	diffused safety glass
Beam angle (optics):	100°
Operating temperature:	-30... +60 °C
Colour rendering (Ra):	> 85
Lamps lifetime:	> 60,000 h
Housing material:	aluminium
Cover material:	safety glass, 4 mm
Height [B] x Width [C]:	29 mm x 40 mm
Length [A]:	365 mm
Weight (net):	450 g
Gross weight:	600 g
Risk group (DIN EN 62471):	free group
Marking:	CE, UKCA, ETL Listed
Mounting accessories:	optional
Dimmable:	via optional accessory
Made in:	Germany

Lamps lifetime in operation hours (L80/B10)