

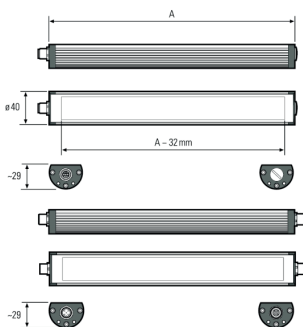

TUBELED_40 Element AC, 540 mm, 220-240V AC

Artikel-Nr.:	119310-03
EAN:	4260556624433

Bestell-Nr.:	119310-03
Modell:	TUBELED_40 Element
Bauform:	LED Aufbauleuchte
Leuchtmittel:	SMD LED
Lampenleistung:	~17 W
Lampenlichtstrom:	2060 lm
Lampenlichtausbeute:	127 lm/W
Lichtverteilung:	direkt
Lichtfarbe:	Tageslichtweiß (5200 - 5700K)
Anschlusswert Leuchte:	220-240V AC ± 10%, 50-60 Hz
Anschluss Leuchte:	M12 S-kodiert
Schutzart:	IP54
Schutzklasse:	I
Entblendung:	Diffusor, PMMA
Abstrahlwinkel:	100°
Betriebstemperatur:	-30... +50 °C
Farbwiedergabe (Ra):	> 80
Lampenlebensdauer:	> 50.000 h
Material Gehäuse:	Aluminium, Endkappen Kunststoff
Material Abdeckung:	PMMA, gefrostet
Höhe [B] x Breite [C]:	29 mm x 40 mm
Länge [A]:	540 mm
Gewicht:	690 g
Bruttogewicht:	900 g
Risikogruppe (DIN EN 62471):	freie Gruppe
Kennzeichnung:	CE, UKCA
Befestigungszubehör:	optional
Gefertigt in:	Deutschland
Besonderheit:	220-240V AC Anschluss, temperaturbeständig



Lampenlebensdauer in Betriebsstunden (L80/B10)



TUBELED_40 Element AC, 540 mm, 220-240V AC

Item number: 119310-03
EAN: 4260556624433

Order number:	119310-03
Model:	TUBELED_40 Element
Type:	LED surface-mounted luminaire
Illuminant:	SMD LED
Power consumption:	~17 W
Lamp luminous flux:	2060 lm
Lamp luminous efficiency:	127 lm/W
Light distribution:	direct
Light colour:	daylight white (5200 - 5700K)
Connected load:	220-240V AC \pm 10%, 50-60 Hz
Connection (connector):	M12 S-type encoded
Degree of protection:	IP54
Class of protection:	I
Glare-free	diffuser sheet for scattered light, PMMA
Beam angle (optics):	100°
Operating temperature:	-30... +50 °C
Colour rendering (Ra):	> 80
Lamps lifetime:	> 50,000 h
Housing material:	aluminium, endcaps made of plastics
Cover material:	PMMA, frosted
Height [B] x Width [C]:	29 mm x 40 mm
Length [A]:	540 mm
Weight (net):	690 g
Gross weight:	900 g
Risk group (DIN EN 62471):	free group
Marking:	CE, UKCA
Mounting accessories:	optional
Made in:	Germany
Feature:	220-240V AC Anschluss, temperaturbeständig

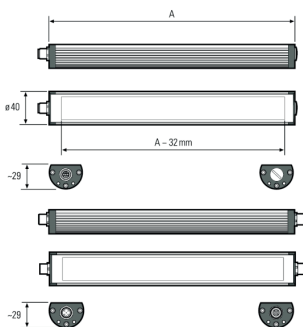

Lamps lifetime in operation hours (L80/B10)